

WHOLESALE CATALOG

Reverse Channel



Standard Channel



RED LED at \$4.00 per ft
Hillsboro , WV



Exclusive North America Distributor for Acer Illumination

Showtime Sign & Design, Inc.

803 South 12th Street - Louisville, Kentucky 40210

LED Orders by Phone **502.356.4529** Free Ground Shipping

PRICE: White **\$6.63** per ft. Red **\$3.37** per ft.

A2



Mini Super Bright

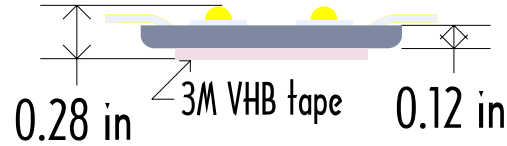

Low Profile Series

Aluminum based Modules are fully encapsulated in epoxy.

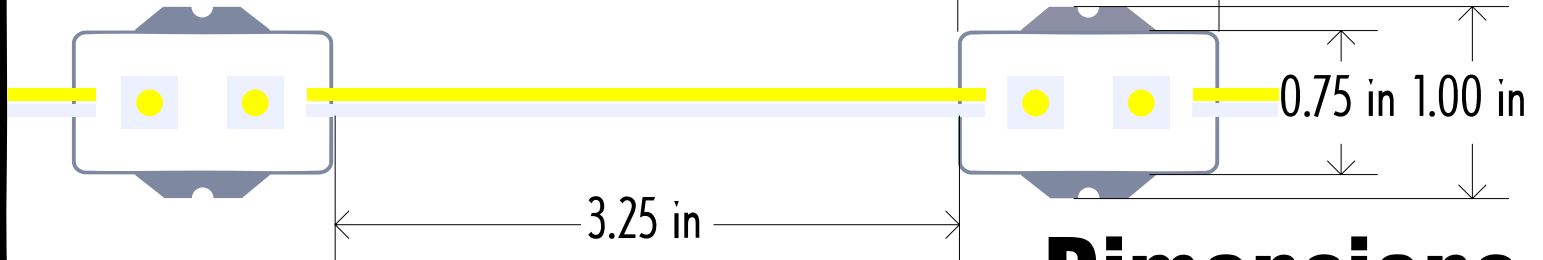

Dimensions

Power Supply Footage Chart:

Power Supply Footage Chart:			Maximum Number of Feet	
Power Supply	Part #	Power Output	White Mini's - (A2W)	Red Mini's - (A2R)
Waterproof 15.8	JA-48330M	15.8 Watts	15	11
Waterproof 30	VB-12030M	30 Watts	30	21.5
Waterproof 60	VA-12060P	60 Watts	60	43

These 2-LED Mini Modules with Aluminum Casing are Packaged in Static Shielding Bags and come as 100 modules - 38 feet long and can be cut to desired lengths

- Weatherproof, suitable for use in dry, damp, and wet locations
- Brilliant, uniform light output
- Backed with 3M VHB tape
- Quick and easy to install
- Long Life
- Energy efficient
- Low profile design
- Low voltage
- Low heat generation.
- Reduces maintenance costs

Model #	Color	Cost per bag	Avg \$ per ft
AR2	RED	\$128	\$3.37
AW2	WHITE	\$252	\$6.63



TECHNOLOGY AT ITS BRIGHTEST
P.O.BOX 17081 - Louisville, Kentucky - 40217-0081

PRICE: White **\$7.05** per ft. Red **\$3.58** per ft.

A4

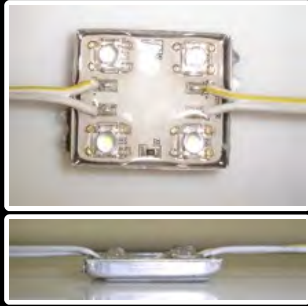

Low Profile Series

Aluminum based Modules are fully encapsulated in epoxy.

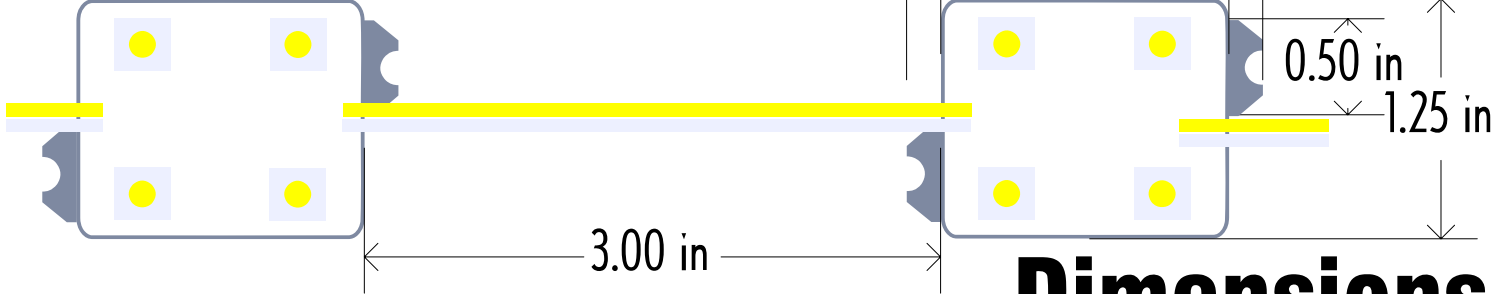

4x Super Bright

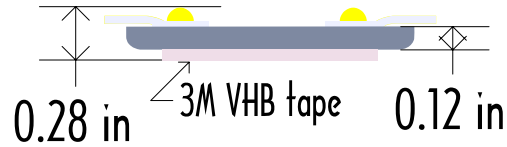

Dimensions

Power Supply Footage Chart:

Power Supply Footage Chart:			Maximum Number of Feet	
Power Supply	Part #	Power Output	4x White - (A4W)	4x Red - (A4R)
Waterproof 15.8	JA-48330M	15.8 Watts	13	10.5
Waterproof 30	VB-12030M	30 Watts	25	20
Waterproof 60	VA-12060P	60 Watts	50	40

These 4-LED Mini Modules with Aluminum Casing are Packaged in Static Shielding Bags and come as 100 modules - 38 feet long and can be cut to desired lengths

- Weatherproof, suitable for use in dry, damp, and wet locations
- Brilliant, uniform light output
- Backed with 3M VHB tape
- Quick and easy to install
- Long Life
- Energy efficient
- Low profile design
- Low voltage
- Low heat generation.
- Reduces maintenance costs

Model #	Color	Cost per bag	Avg \$ per ft
AR4	RED	\$136	\$3.58
AW4	WHITE	\$268	\$7.05



TECHNOLOGY AT ITS BRIGHTEST
P.O.BOX 17081 - Louisville, Kentucky - 40217-0081

PRICE: White \$7.85 per ft. Red \$4.00 per ft.

M3

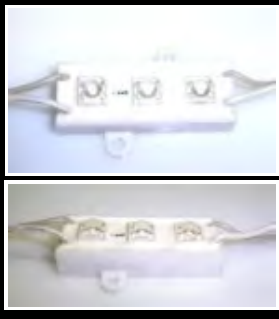

Great Bright

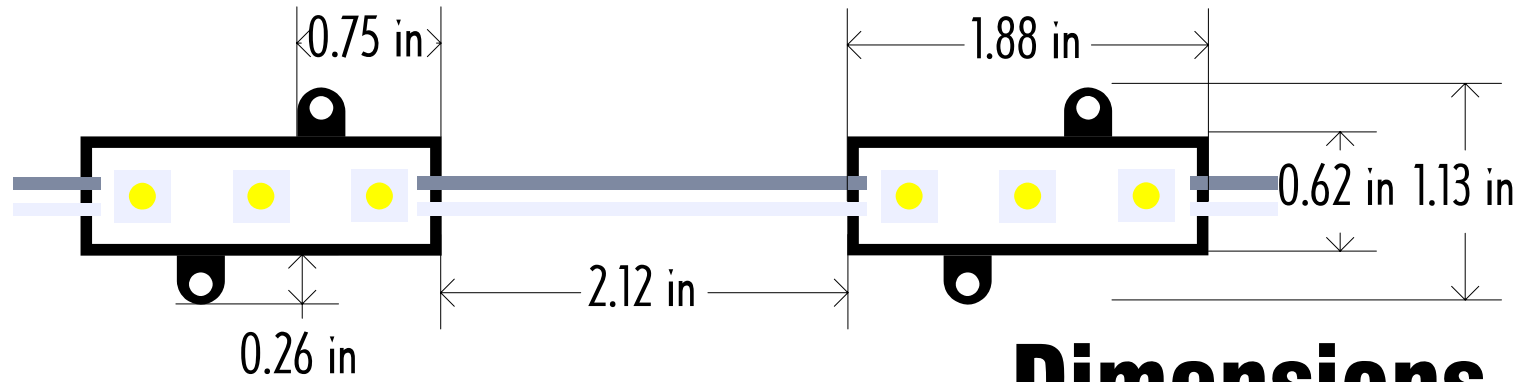
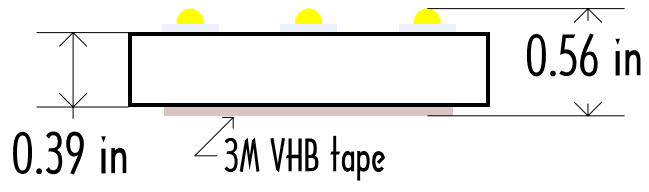

Dimensions

Power Supply Footage Chart:

			Maximum Number of Feet	
Power Supply	Part #	Power Output	Bright White - (M3W)	Bright Red - (M3R)
Waterproof 15.8	JA-48330M	15.8 Watts	15	11
Waterproof 30	VB-12030M	30 Watts	30	21.5
Waterproof 60	VA-12060P	60 Watts	60	43

These 3-LED Mini Modules with PVC Casing are Packaged in Static Shielding Bags and come as 80 modules - 26.5 feet long and can be cut to desired lengths

- Weatherproof, suitable for use in dry, damp, and wet locations
- Brilliant, uniform light output
- Backed with 3M VHB tape
- Quick and easy to install
- Long Life
- Energy efficient
- Low profile design
- Low voltage
- Low heat generation.
- Reduces maintenance costs

Model #	Color	Cost per bag	Avg \$ per ft
M3R	RED	\$106	\$4.00
M3W	WHITE	\$208	\$7.75



LED Power Supplies

Weatherproof.
Suitable for use in dry, damp, and wet locations.
1-Year Warranty

\$24.00 ea.

A-48330M
Low Profile Series

15.8-Watt

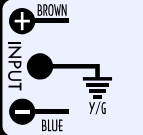
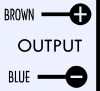

	MODEL JA-48330M Water Proof Electronic LED Driver	
INPUT VOLTAGE 120 VOLTS CURRENT 0.21 AMPS	OUTPUT DC 12VOLTS POWER 15.8WATTS	

\$29.00 ea.

VB-12030M
Low Profile Series

30-Watt

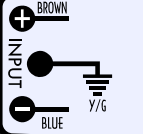
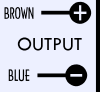

	MODEL VB-12030M Water Proof Electronic LED Driver	
INPUT VOLTAGE 120 VOLTS CURRENT 0.49 AMPS	OUTPUT DC 12VOLTS POWER 30WATTS	

\$36.00 ea.

VA-12060P
Dual Output

60-Watt

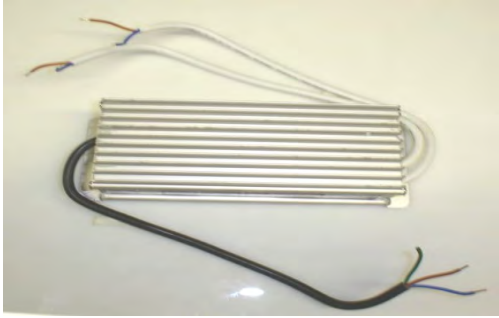

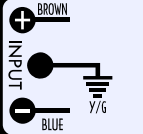
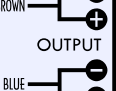
	MODEL VA-12060P Water Proof Electronic LED Driver	
INPUT VOLTAGE 120 VOLTS CURRENT 0.67 AMPS	OUTPUT DC 12VOLTS POWER 60WATTS	



LED WHOLESALE ORDER LIST

ITEM	DESCRIPTION	LINEAR FEET PER BAG	PRICE PER BAG	How Many BAGS
M3W	PVC, Great Bright, 3 Diodes per Module, 3 Modules per LF, 12V, WHITE	26.5	(80 Units) \$ 208	
A4W	4-LED, 4x Super Bright, Aluminum Casing, 4 Diodes per Module, 3 Modules per LF, 12V, WHITE	38	(100 Units) \$ 268	
A2W	2-LED, Mini Super Bright, Aluminum Casing, 2 Diodes per Module, 3 Modules per LF, 12V, WHITE	38	(100 Units) \$ 252	
M3R	PVC, Great Bright, 3 Diodes per Module, 3 Modules per LF, 12V, RED	26.5	(80 Units) \$ 106	
A4R	4-LED, 4x Super Bright Modules, Aluminum Casing, 4 Diodes per Module, 3 Modules per LF, 12V, RED	38	(100 Units) \$ 136	
A2R	2-LED, Mini Super Bright, Aluminum Casing, 2 Diodes per Module, 3 Modules per LF, 12V, RED	38	(100 Units) \$ 128	

LED POWER SUPPLY

ITEM	DESCRIPTION	PRICE PER ITEM	How Many
60W	60 Watt Waterproof Power Supply	\$ 36.00	
30W	30 Watt Waterproof Power Supply	\$ 29.00	
15.8W	15.8 Watt Waterproof Power Supply	\$ 24.00	

Exclusive Dealership: **Showtime Sign & Design, Inc.**
 803 S. 12th Street
 Louisville, KY 40210
 (502) 356-4529

WIRING DIAGRAM

Spec Sheet for



Products Only



**120-Volt INPUT
to LED Modules**

**12-Volt OUTPUT
to LED Modules**

Weather Proof LED Modules

MODEL NUMBER		LED WIRE COLOR
A2W / A2R / A4W / A4R	Positive (+)	White / Yellow
Aluminum Body	Negative (-)	White
M3W / M3R	Positive (+)	Gray
Plastic Body	Negative (-)	White



Power Supply Footage Chart:

Power Supply	Part #	Power Output	Maximum Number of Feet					
			A2W	A2R	A4W	A4R	M3W	M3R
Waterproof 15.8	JA-48330M	15.8 Watts	15	11	13	10.5	15	11
Waterproof 30	VB-12030M	30 Watts	30	21.5	25	20	30	21.5
Waterproof 60	VA-12060P	60 Watts	60	43	50	40	60	43

ACER ILLUMINATION'S LED LIGHTING SYSTEM WARRANTY

ACER Illumination warrants its LED and Power Supply Products to be free from defects in materials and workmanship for the warranty period stated below, provided that the LED products and Power supplies are used together as a system and no other third party devices are used in the system. Should any LED product or Power Supply fail to perform as specified during the warranty period, ACER Illumination will replace, or at its option, repair, free of charge, all defective product in accordance with the terms and condition set forth herein.

Product

Description	Part No.	Warranty Period*
PVC, White, 3 Diodes	M3W	48 Months
Aluminum, White, 4 Diodes	A4W	48 Months
Aluminum, White, 2 Diodes	A2W	48 Months
PVC, Red, 3 Diodes	M3R	60 Months
Aluminum, Red, 4 Diodes	A4R	60 Months
Aluminum, Red, 2 Diodes	A2R	60 Months

***Warranty Period subject to all terms and conditions listed herein.**

TERMS AND CONDITIONS

Usage

This limited warranty is based on reasonable indoor and outdoor usage in architectural applications for image identification. Normal operating conditions are defined as 24 hours per day, 7 days per week continuous use in typical outdoor heat and humidity environmental conditions. All LED systems, to varying degrees, have some amount of light degradation over the life of the product. This limited warranty is valid only when the LED products and Power Supplies are used together for their intended use and properly installed and wired in accordance with all instructions, building codes, National Electric Code, and all other domestic and international safety agencies that are recognized as having applicable safety requirements.

Any use outside intended use or conditions or the conditions stated in ACER Illumination's written data sheets/instructions, or stated herein, including the use of third party dimming, flashing, or other effect devices, extreme environmental conditions or any other unintended usage will void this warranty.

Warranty Claim Assistance

Should an ACER Illumination product fail under this warranty please contact ACER Illumination for replacement. Should circumstances arise that preclude the remedying of warranted defects by product repair or replacement, ACER Illumination shall, at its discretion and upon receipt and verification of defective product, refund to the buyer the purchase price or portion of purchase price theretofore paid to ACER Illumination.

Limitation of Liability

UNDER NO CIRCUMSTANCES SHALL ACER ILLUMINATION BE LIABLE FOR ANY INCIDENTAL OR CONSEQUENTIAL LOSS OR DAMAGE WHATSOEVER ARISING OUT OF, OR IN ANY WAY RELATED TO ANY DEFECT IN OR NON PERFORMANCE OF THE PRODUCTS. NO WARRANTY OF MERCHANTABILITY OR FITNESS FOR A PARTICULAR PURPOSE IS MADE OR IMPLIED. Furthermore, ACER Illumination shall not be responsible for any other costs, including installation or field support labor or loss of profits, income or revenue. ACER Illumination shall not be responsible for minimum illumination levels or other performance criteria. ACER Illumination reserves the right to test and examine all products returned under this warranty to evaluate proper usage, determine the cause of failure, and make a determination, in its sole judgment whether the products are defective and covered by this warranty.

